

BACH

Massimiliano Raggi



AP SMALL



AP LARGE



Lampada a parete, in due dimensioni, caratterizzate dall'alternarsi di tubi in metallo ed in plexiglass (ricorda le canne di un organo). Prodotto molto eclettico adatto per uso residenziale e contract: sia in un elegante salotto o nelle aree comuni e nel corridoio di un hotel. Un modello geometrico nascosto dietro ai tubi arricchisce gli effetti di luce, creando un gioco di ombre e sfumature sulle parti in plexiglass.

Wall lamp, in two sizes, characterized by the alternation of metal and plexiglass tubes (it reminds of organ pipes). Very eclectic product suitable for residential and contract use: both in an elegant living room as well as in the public areas and in the corridor of a hotel. A geometric model hidden behind the tubes enriches the light effects, creating a play of shadows and shades on the plexiglass parts.

SPECIFICHE PRODOTTO / PRODUCT SPECIFICS

p2

BACH AP SMALL

p3

BACH AP LARGE

p4



STRUTTURA / FRAME



Bronzo spazzolato chiaro opaco
Matt light satin bronze

DIFFUSORE / DIFFUSER



Plexiglass satinato
Satin plexiglass

FONTE LUMINOSA / LIGHT SOURCE



GU10 LED
Utilizzabili lampadine LED fino
alla massima potenza disponibile
sul mercato

*You can use LED light bulbs of
the highest available wattage*

AP SMALL / AP LARGE

2 X GU10
Lampadine LED
LED light bulbs



USA / LIGHT SOURCE



GU10 LED
You can use LED light bulbs of
the highest available wattage

AP SMALL / AP LARGE

2 X GU10
LED light bulbs



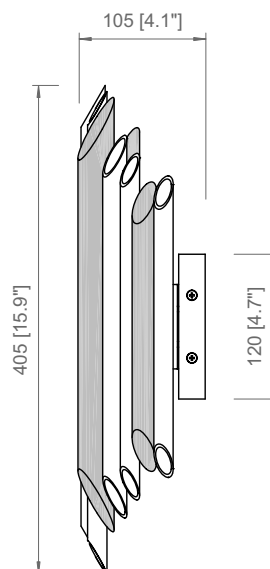
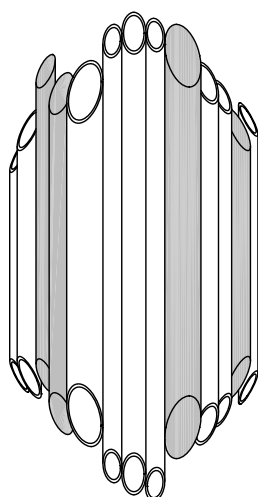
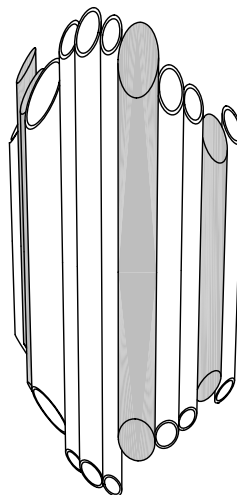
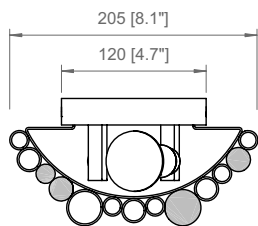

PRODOTTO / PRODUCT

BOX 1

PESO / WEIGHT
3 kg / 6.6 lbs

L: 42 cm / 16.5"
W: 42 cm / 16.5"
H: 16 cm / 6.3"

PESO / WEIGHT
4 kg / 8.8 lbs

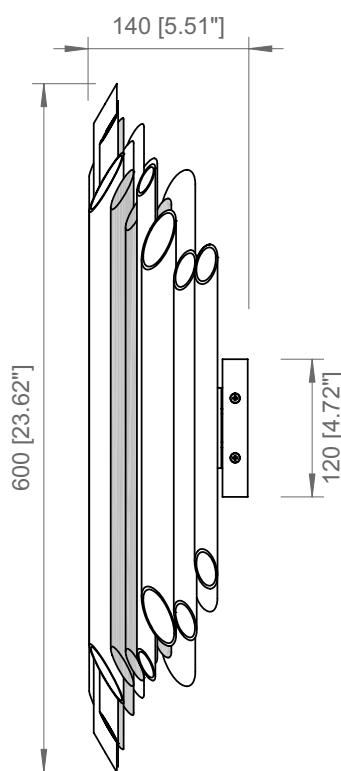
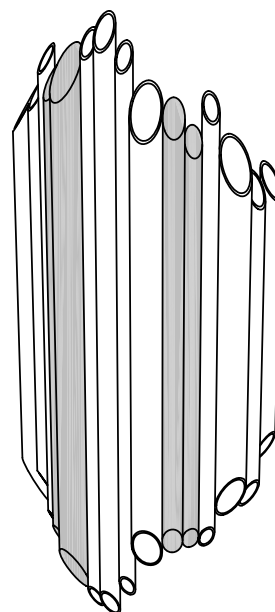
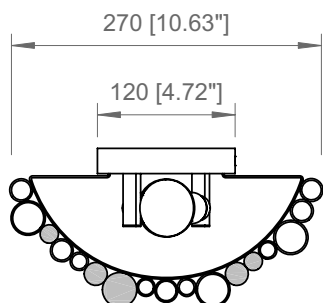

PRODOTTO / PRODUCT

BOX 1

PESO / WEIGHT
6,5 kg / 22 lbs

L: 51 cm / 20"
W: 51 cm / 20"
H: 26 cm / 10.2"

PESO / WEIGHT
7,5 kg / 16.5 lbs



Copyright and/or design rights subsist in this drawing. No part of this drawing may be reproduced in any material form (including photocopying or storing in any medium electronic means, whether or not intentionally and whether or not as part or a larger publication) without the express permission of the copyright owner, Contardi Lighting S.r.l.. Further and without prejudice to the above, this drawing and all information relating thereto is confidential, and shall not be communicated to a third party without the consent of Contardi lighting srl. Contardi lighting srl asserts all rights to be identified as the author of the work and otherwise.

WARNING: The doing of any unauthorised act in relation to a copyright work may result in both a civil claim for damages and criminal prosecution.

CONTARDI LIGHTING Srl

ITALY HEADQUARTERS

www.contardi-italia.com / sales@contardi-italia.it

CONTARDI USA Inc

USA BRANCH

www.contardi-usa.com / sales@contardi-usa.com

