

# BACH

*Massimiliano Raggi*



AP SMALL



AP LARGE



Lampada a parete, in due dimensioni, caratterizzate dall'alternarsi di tubi in metallo ed in plexiglass (ricorda le canne di un organo). Prodotto molto eclettico adatto per uso residenziale e contract: sia in un elegante salotto o nelle aree comuni e nel corridoio di un hotel. Un modello geometrico nascosto dietro ai tubi arricchisce gli effetti di luce, creando un gioco di ombre e sfumature sulle parti in plexiglass

*Wall lamp, in two sizes, characterized by the alternation of metal and plexiglass tubes (it reminds of organ pipes). Very eclectic product suitable for residential and contract use: both in an elegant living room as well as in the public areas and in the corridor of a hotel. A geometric model hidden behind the tubes enriches the light effects, creating a play of shadows and shades on the plexiglass parts.*

## SPECIFICHE PRODOTTO / PRODUCT SPECIFICS

p2

BACH AP SMALL

p3

BACH AP LARGE

p4



---

## STRUTTURA / FRAME



Bronzo spazzolato chiaro opaco  
*Matt light satin bronze*



Cromo  
*Chrome*

---

## DIFFUSORE / DIFFUSER



Plexiglass satinato  
*Satin plexiglass*

---

## FRONTE LUMINOSA / LIGHT SOURCE



GU10 LED  
Utilizzabili lampadine LED fino  
alla massima potenza disponibile  
sul mercato

*You can use LED light bulbs of  
the highest available wattage*

### AP SMALL / AP LARGE

2 X GU10  
Lampadine LED  
*LED light bulbs*



---

## USA / LIGHT SOURCE



GU10 LED  
You can use LED light bulbs of  
the highest available wattage

### AP SMALL / AP LARGE

2 X GU10  
LED light bulbs



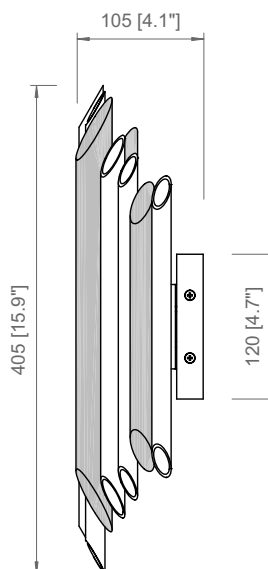
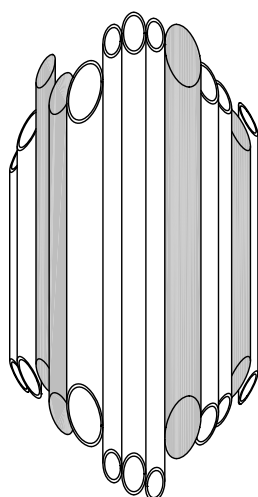
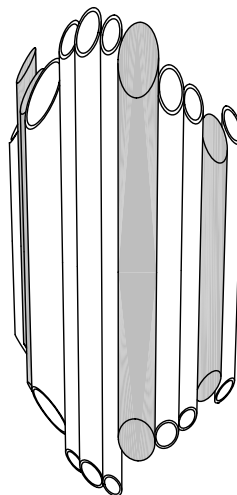
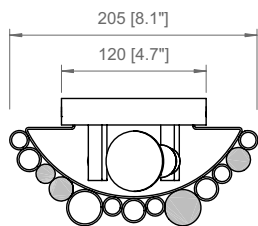

PRODOTTO / PRODUCT

BOX 1

PESO / WEIGHT  
3 kg / 6.6 lbs

L: 42 cm / 16.5"  
W: 42 cm / 16.5"  
H: 16 cm / 6.3"

PESO / WEIGHT  
4 kg / 8.8 lbs

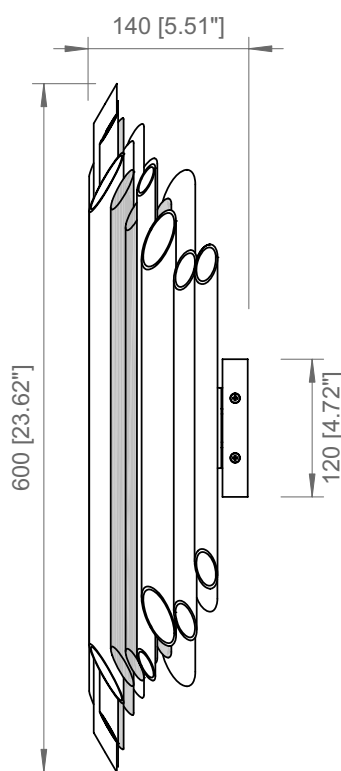
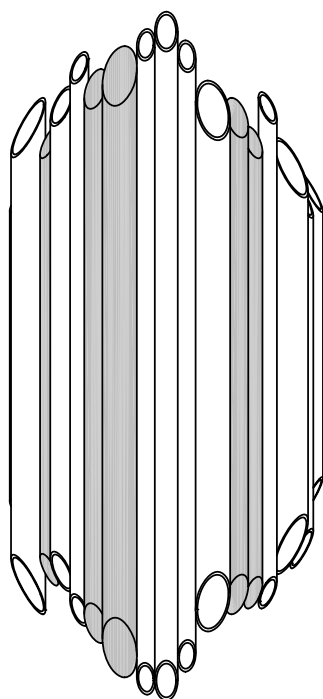
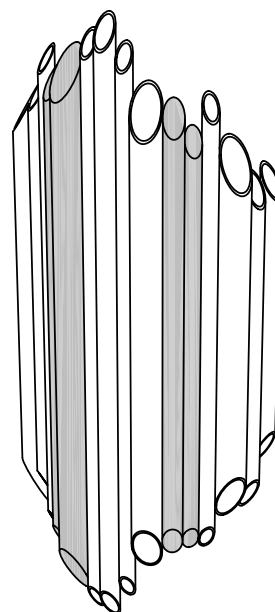
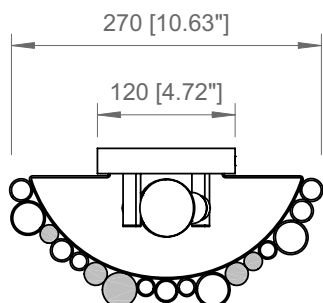

PRODOTTO / PRODUCT

BOX 1

PESO / WEIGHT  
6,5 kg / 22 lbs

L: 51 cm / 20"  
W: 51 cm / 20"  
H: 26 cm / 10.2"

PESO / WEIGHT  
7,5 kg / 16.5 lbs



Copyright and/or design rights subsist in this drawing. No part of this drawing may be reproduced in any material form (including photocopying or storing in any medium electronic means, whether or not intentionally and whether or not as part or a larger publication) without the express permission of the copyright owner, Contardi Lighting S.r.l.. Further and without prejudice to the above, this drawing and all information relating thereto is confidential, and shall not be communicated to a third party without the consent of Contardi lighting srl. Contardi lighting srl asserts all rights to be identified as the author of the work and otherwise.

**WARNING:** The doing of any unauthorised act in relation to a copyright work may result in both a civil claim for damages and criminal prosecution.

---

**CONTARDI LIGHTING Srl**

ITALY HEADQUARTERS

[www.contardi-italia.com](http://www.contardi-italia.com) / [sales@contardi-italia.it](mailto:sales@contardi-italia.it)

**CONTARDI USA Inc**

USA BRANCH

[www.contardi-usa.com](http://www.contardi-usa.com) / [sales@contardi-usa.com](mailto:sales@contardi-usa.com)

