

BEAM

Maria Vafiadis

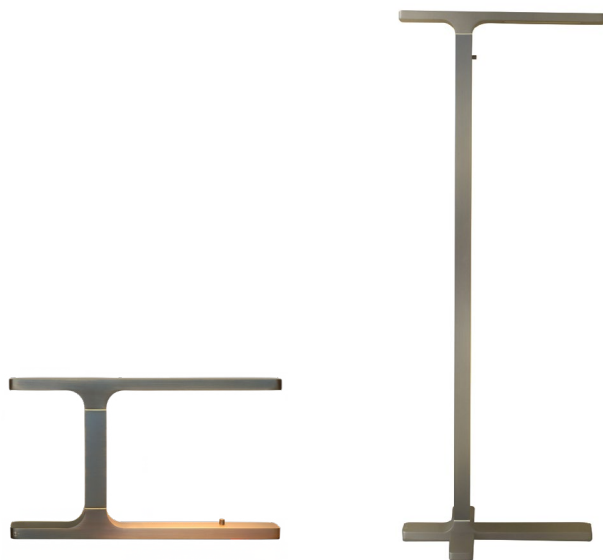

TA

FL



Beam rappresenta un'evoluzione nell'interpretazione della "lampada di scopo", dall'inglese "task light", categoria a cui appartengono le lampade da scrittoio e da lettura. L'innovazione è rappresentata dal fatto che si muove la luce e non la lampada. Attraverso il pulsante a tre fasi, la luce diventa orientabile ed indirizzabile a seconda della necessità di chi la usa, senza dover muovere la struttura.

Beam represents an evolution in the interpretation of the "lamp of purpose", from the English "task light", a category lamps for writing and reading belong to. Innovation is represented by the fact that what is moving is the light, but not the lamp. Through the three-phase switch, the light becomes adjustable and addressable according to the user's needs without having to move the structure.

SPECIFICHE PRODOTTO / PRODUCT SPECIFICS

p2

BEAM FL

p3

BEAM TA

p4



STRUTTURA / FRAME

Bronzo spazzolato
Satin bronze

CAVO - INTERRUTTORE / CABLE - SWITCH

Tessuto nero
Black fabric

FL / TA
L: 200 cm
L: 78,7"

TA
Comando a pulsante su base
per indirizzare la luce
*Push-button control on the base
to direct the light*

FL
Comando a pulsante su struttura
per indirizzare la luce
*Push-button control on the
stem to direct the light*

FONTE LUMINOSA / LIGHT SOURCE

Strip LED
Luce orientabile (180°)
Tre posizioni: sx, dx e centrale
*Adjustable light (180°)
Three positions: left, right and central*

FL / TA
2 X 4W
Strip LED
Lumen: 880
2.700 K; CRI: >90

USA / LIGHT SOURCE

Black cable

FL / TA
L: 78,7"

TA
Push-button control on the base
to direct the light

FL
Push-button control on the
stem to direct the light

USA / LIGHT SOURCE

Strip LED
Adjustable light (180°)
Three positions: left, right and central

FL / TA
2 X 4W
Strip LED
Lumen: 880
2.700 K; CRI: >90

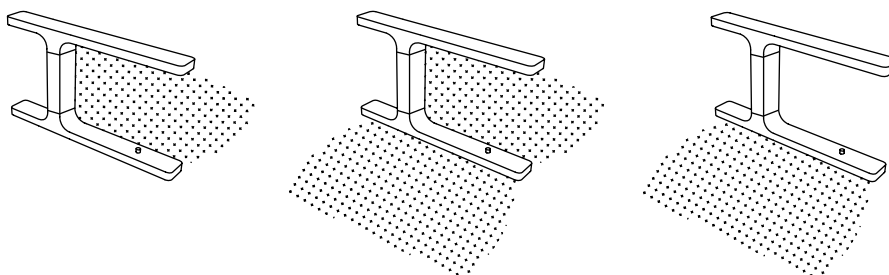

Beam TA e FL

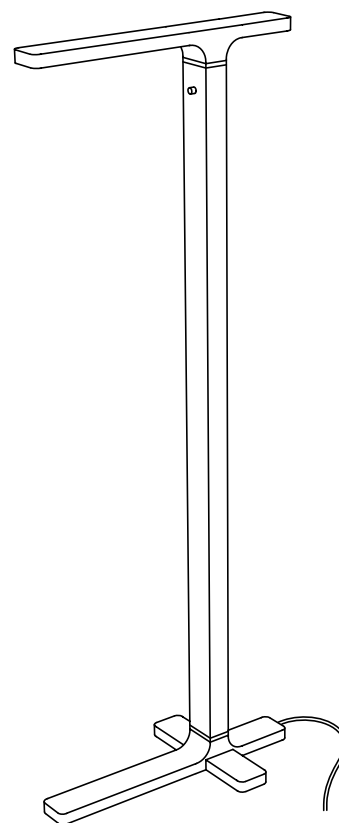
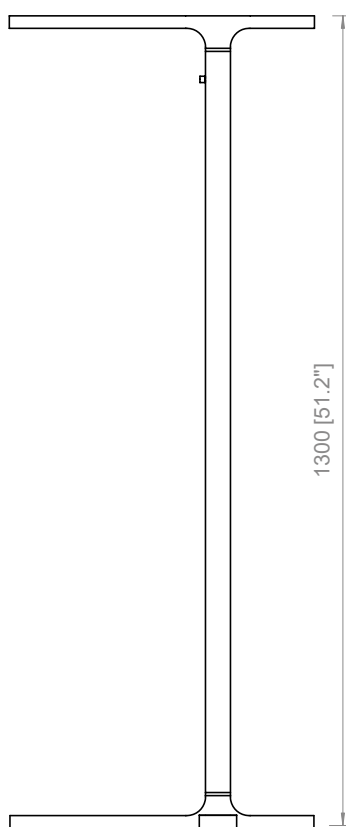
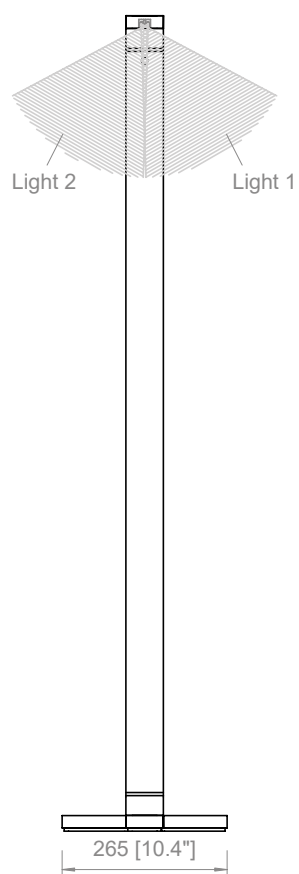
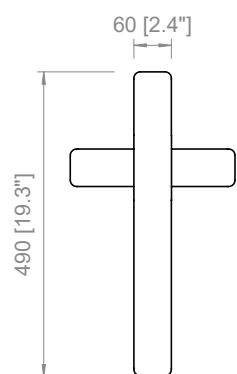

PRODOTTO / PRODUCT

PESO / WEIGHT
11,5 kg / 25,3 lbs

BOX 1

L: 59 cm / 23.2"
W: 35 cm / 13.7"
H: 139 cm / 54.7"

PESO / WEIGHT
13 kg / 28.6 lbs

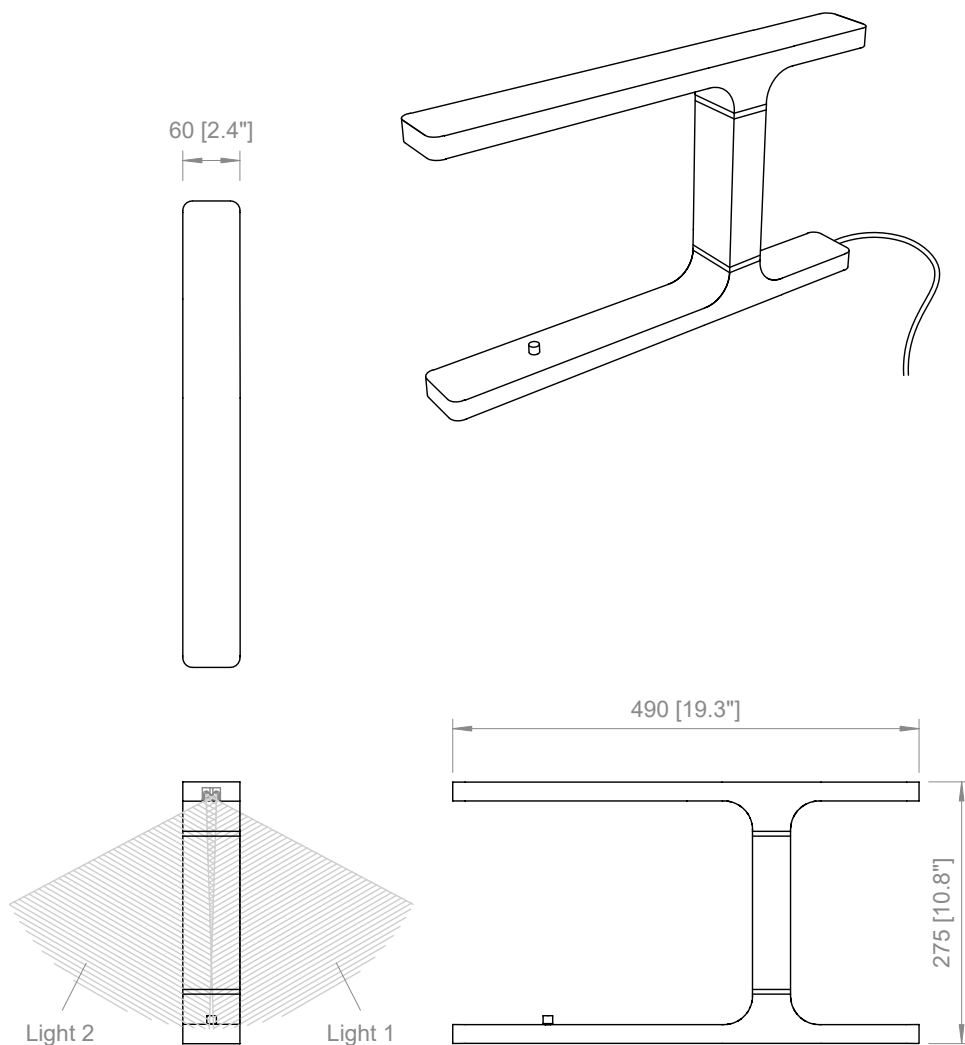

PRODOTTO / PRODUCT

PESO / WEIGHT
4 kg / 8.8 lbs

BOX 1

L: 12 cm / 4.7"
W: 41 cm / 16.1"
H: 67 cm / 26.3"

PESO / WEIGHT
5 kg / 11 lbs



Copyright and/or design rights subsist in this drawing. No part of this drawing may be reproduced in any material form (including photocopying or storing in any medium electronic means, whether or not intentionally and whether or not as part or a larger publication) without the express permission of the copyright owner, Contardi Lighting S.r.l.. Further and without prejudice to the above, this drawing and all information relating thereto is confidential, and shall not be communicated to a third party without the consent of Contardi lighting srl. Contardi lighting srl asserts all rights to be identified as the author of the work and otherwise.

WARNING: The doing of any unauthorised act in relation to a copyright work may result in both a civil claim for damages and criminal prosecution.

CONTARDI LIGHTING Srl

ITALY HEADQUARTERS

www.contardi-italia.com / sales@contardi-italia.it

CONTARDI USA Inc

USA BRANCH

www.contardi-usa.com / sales@contardi-usa.com

