

Tenebra

Jan Van Lierde



SO



SO BATTERY



Tenebra è la prima lampada a sospensione a batteria ricaricabile IP65 della collezione outdoor di Contardi. Declinata in due varianti differenti: TENEBRA con luce spot senza diffusore e TENEBRA CRYSTAL con diffusore in cristallo sintetico. TENEBRA CRYSTAL si caratterizza per i diffusori di cristallo sintetico che conferiscono colore e tridimensionalità alla luce. Disponibile nelle versioni portabile a batteria o cablata, la versione a batteria, con autonomia di 8/9 ore, si ricarica attraverso porta USB tipo C comunemente usata per smartphone e tablet di ultima generazione. Fornita con accessori e cavo in acciaio per essere “agganciata” ed installata nei contesti più svariati, dal ramo di un albero, ad un pergolato piuttosto che ad una tenda da esterni. L'accensione avviene attraverso la pressione del tubo.

Tenebra is the first IP65 rechargeable battery suspension lamp of Contardi outdoor collection. Available in two different variants: Tenebra with spot light without diffuser and Tenebra Crystal with diffuser in “synthetic crystal”. Tenebra Crystal is characterised by the synthetic crystal diffusers that give colour and three-dimensionality to the light. Available in battery-powered or wired versions, the battery-powered version, with about 9 hour autonomy, can be recharged through a USB type-C port commonly used for latest-generation smartphones and tablets. Supplied with accessories and steel cable to be “hooked” and installed in a wide variety of contexts, from a tree branch to a pergola arbour rather than an outdoor tent. Switch by the pressure of the tube.

SPECIFICHE PRODOTTO / PRODUCT SPECIFICS

p.2

TENEBRA SO
TENEBRA SO BATTERY

p.4

p.5

ACCESSORI TENEBRA - TENEBRA ACCESSORIES

p.6

STRUTTURA / FRAME



Laccato nero opaco
Matt black lacquered

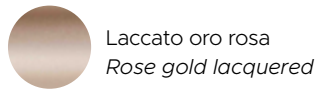

Laccato oro rosa
Rose gold lacquered



Laccato argento
Silver lacquered

ACCESSORI / ACCESSORIES

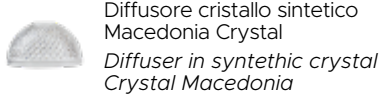

Diffusore cristallo sintetico
Macedonia Crystal
*Diffuser in synthetic crystal
Crystal Macedonia*

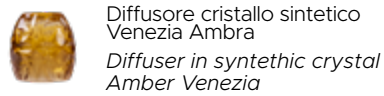

Diffusore cristallo sintetico
Venezia Ambra
*Diffuser in synthetic crystal
Amber Venezia*

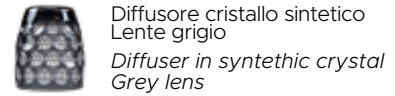

Diffusore cristallo sintetico
Lente grigio
*Diffuser in synthetic crystal
Grey lens*

ACCESSORI VERSIONE BATTERIA / BATTERY VERSION ACCESSORIES



ACCESSORI INCLUSI

1 x staffa per attacco a soffitti + 1 x griplock
+ 1 x bloccacavo + 1 x cavo in acciaio l. 2m
+ 1 x gancio standard

INCLUDED ACCESSORIES

1 x ceiling attachment + 1 x griplock
+ 1 x screw lock + 1 x steel cable l. 2m
+ 1 x standard hook



ACCESSORI "A" (non inclusi)

+ 1 x cavo in acciaio l.10m + 1 x gancio design

ACCESSORIES "A" (not included)

+ 1 x steel cable l.10m + 1 x design hook



ACCESSORI "B" (non inclusi)

1 x tirante + 2 x bloccacavo
+ 1 x cavo in acciaio l.10m + 6 x griplock

ACCESSORIES "B" (not included)

1 x tie rod + 2 x screw lock
+ 1 x steel cable l.10m + 6 x griplock

CAVO / CABLE

Tessuto nero
Black fabric

SO
L: 2000 mm
L: 78.7"

FRONTE LUMINOSA / LIGHT SOURCE

220-240V



LED module



1 x 3W
LED module
Emissione / Light emission: 500 Lm
2.700 K; CRI: >90
IP65

VERSIONE BATTERIA BATTERY VERSION



Dimmerabile / Dimmable

Autonomia: 7/8 ore
Cicli di vita: 600
Tempi di ricarica: circa 5/6 ore
Cavetto di ricarica USB tipo C fornito,
alimentatore non fornito

*Autonomy: 7/8 hours
Lifestyle cycles: 600
Charging time: 5/6 hours
USB cable type C supplied,
charger adapter not supplied*



110V



LED module



1 x 3W
LED module
Light emission: 500 Lm
2.700 K; CRI: >90
IP65

BATTERY VERSION



Dimmable

Autonomy: 7/8 hours
Lifestyle cycles: 600
Charging time: 5/6 hours
USB cable type C supplied,
charger adapter not supplied



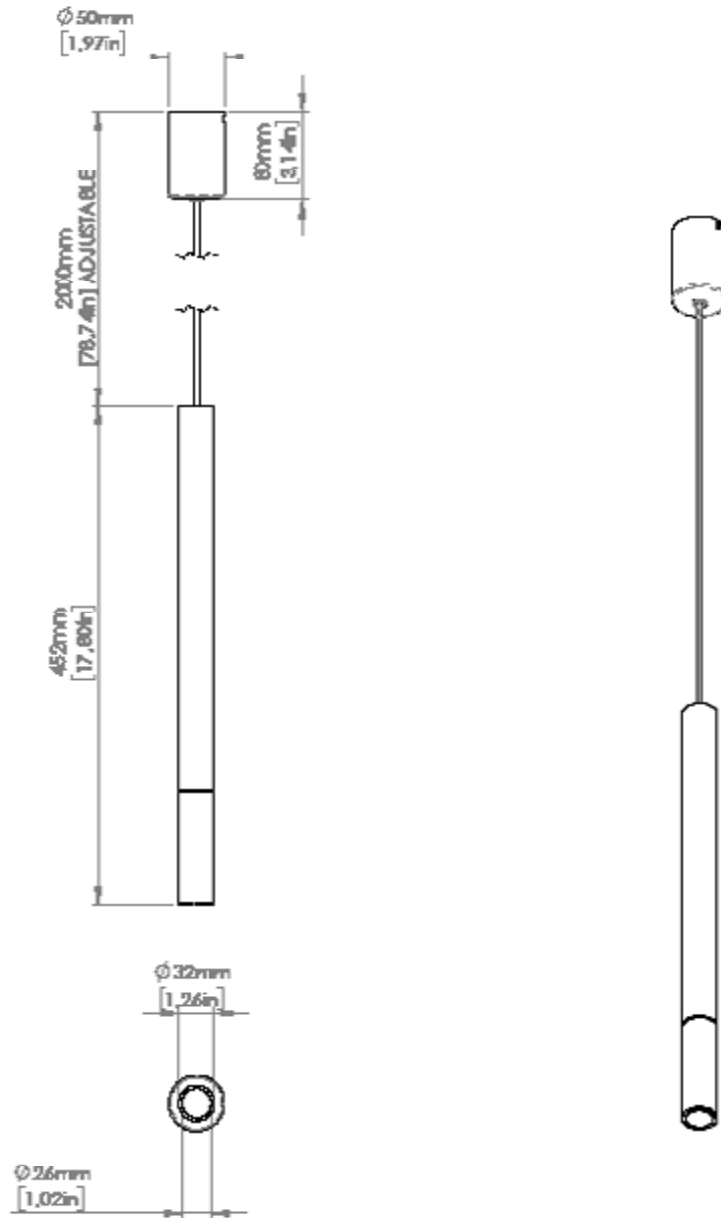

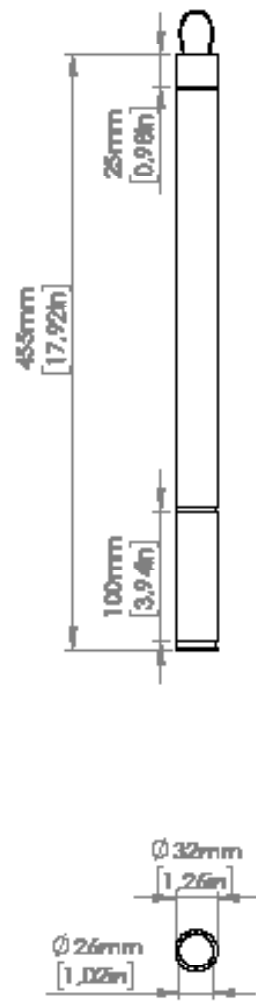

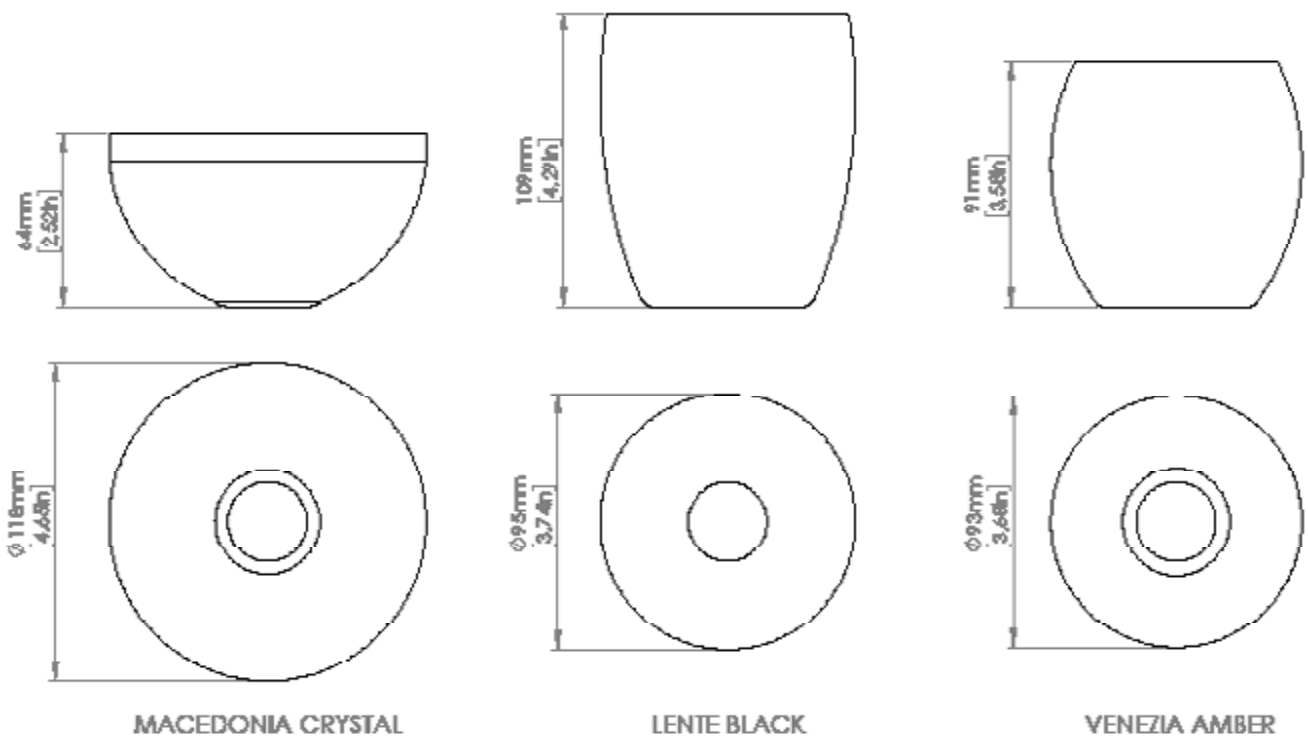

Copyright and/or design rights subsist in this drawing. No part of this drawing may be reproduced in any material form (including photocopying or storing in any medium electronic means, whether or not intentionally and whether or not as part or a larger publication) without the express permission of the copyright owner, Contardi Lighting S.r.l.. Further and without prejudice to the above, this drawing and all information relating thereto is confidential, and shall not be communicated to a third party without the consent of Contardi lighting srl. Contardi lighting srl asserts all rights to be identified as the author of the work and otherwise.

WARNING: The doing of any unauthorised act in relation to a copyright work may result in both a civil claim for damages and criminal prosecution.

CONTARDI LIGHTING Srl

ITALY HEADQUARTERS

www.contardi-italia.com / sales@contardi-italia.it

CONTARDI USA Inc

USA BRANCH

www.contardi-usa.com / sales@contardi-usa.com

